

2016

SUPPLEMENT

SEADOG[®]LINE
QUALITY MARINE GEAR

Moving Ahead With Sea-Dog

As the North American marine market continues to strengthen and grow, Sea-Dog is looking forward to the 2016 selling season. Once again, we are introducing a broad assortment of interesting new products which will be available in the fall of 2015.

A new upgraded version of the popular single and dual mini-compact horns will have an over-molded steel housing that allows us to offer an unprecedented Five Year Warranty on these two new horns. A contemporary update on a classic product is our beautiful new stainless steel "can style" spotlight that is waterproof and also comes with a Five Year Warranty. Other new products include LED lighted handrails, an upgraded, brighter bulb docking light set, LED drink holders, a cast stainless steel adjustable wrench, more new cordage products, and a new smaller boat hook to broaden our "Build a Better Boat Hook" line of boat hooks that we introduced last year. All of these items, plus a lot more, are shown in this copy of the 2016 Supplement (we print new catalogs in odd numbered years and new product supplements in even numbered years) and also on our website.

As we have done for the past 95 years, we continue to work to provide quality marine accessories at affordable prices. Sea-Dog takes great pride in our ability to maintain a strong balance between competitive cost and high quality because we want our customers to always be confident in every Sea-Dog product they buy. We want to provide a satisfactory purchasing experience every time, and if for some reason we don't, we want to hear about it so that we can take care of it.

The support of all of our customers, including distributors, boat builders, wholesalers, dealers, and the end user has been the key element of our longevity and continued success, and we remain committed to maintaining that level of trust and support. We are committed to providing all of our customers with the products and service they expect, and we welcome and appreciate any and all feedback. Because we only sell wholesale and not direct to the

public, it's always important to hear from all of our customers, and most especially the end user – it is our hope that all of our customers feel free to contact us by phone (always answered by a live person during regular business hours) or e-mail anytime.

Thank you for making Sea-Dog your supplier of choice – your support is vital to our success and is greatly appreciated.



Sea-Dog does not sell to the general public – we only sell to boat builders and wholesalers. For information on how to purchase our products, visit the "Where to Buy" page on our website.

To Order

To place an order, please contact us in one of the following ways (e-mail preferred for order accuracy):

E-mail: orders@sea-dog.com
Phone: 1-866-732-3641
Fax: 425-339-1345

Minimum Orders

Orders less than \$100 incur a \$10 handling fee. For maximum cost effectiveness, we recommend each item's standard packaging quantities are maintained.

There is also a \$5 surcharge for all drop ship orders.

Returns

A Return Goods Authorization (RGA) number must be obtained prior to any return. Credit will not be issued for goods returned without prior authorization. Special order items cannot be returned. Please include the following with your return:

1. List of returned items
2. Invoice number with Sea-Dog order number and date of purchase
3. Reason for return

Return items are subject to a minimum 20% restocking charge and must be ready for resale in original packaging. Customer is responsible for shipping charges of their return. Address returns to:

Sea-Dog Corporation
3402 Smith Avenue
Everett, WA 98201 USA

-1s, -2s, -3s, -5s, & -7s

Items available in retail display packaging are identified with a -1, -2, -3, -5, -7 after the Sea-Dog part number. More specifically:

- 1: Hanging card, bagged with header card, or in a clamshell
- 2: Higher quantity display packaging
- 3: Full color box
- 5: Point of Purchase (POP) display: clear container with set number of that item.
- 7: Strip merchandiser display: hanging displays, each consisting of 10 items.

Contact Us

Toll Free: 1-866-732-3641
Orders: orders@sea-dog.com
OEM Customer Service: custservo@sea-dog.com
After Market Customer Service: custserva@sea-dog.com
Sales: sales@sea-dog.com
Graphics: graphics@sea-dog.com
Operations: operations@sea-dog.com
Website: www.sea-dog.com



CLASSIC

ELEGANCE



All Stainless Steel Halogen Spot/Flood Light

405720-3

- Cast 316 stainless steel base with a stamped 304 stainless steel housing and reflector
- Waterproof – IP 67 rating
- Five year warranty
- 100 watt spot/90 watt flood mode H4 halogen bulb
- 165,000 candlepower
- Includes joy stick control panel and 15' cable
- Digital connection using regular phone jack cable
- Two-speed rotation
- Wireless remote control and 12V second station wireless remote sold separately

Sea-Dog search lights undergo a rigorous quality control and testing program: impact and vibration absorption, water ingress protection, light beam output integrity, corrosion resistance, UV stabilization, temperature endurance, jam protection, and more.

SEADOG[®]LINE
QUALITY MARINE GEAR

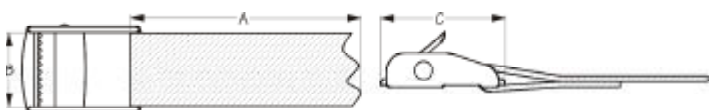

WEBBING CAM BUCKLE STRAP

Stainless/Nylon Webbing



Bulk	Display	A	B	C	Type	Wt.(lb.)	Std. Pack
199101	199101-1	Buckle Only	1"	1-3/4"	Light Duty	.08	10 ea
199102	199102-1	Buckle Only	1"	1-3/4"	Heavy Duty	.10	10 ea
199121	199121-1	8 Feet	1"	1-3/4"	Light Duty	.35	10 ea
199122	199122-1	8 Feet	1"	1-3/4"	Heavy Duty	.37	10 ea

Cast 304 stainless steel buckles are available as the buckle only or with an 8' webbing strap attached. The light duty buckle has a working load limit of 550 pounds and the heavy duty buckle has a working load limit of 880 pounds.

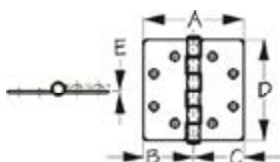

BUTT HINGE WITH BEARINGS/COMMERCIAL PATTERN

Investment Cast 316 Stainless



Bulk	Display	A	B	C	D	E	Fastener	Wt.(lb.)	Std. Pack
205243	n/a	3"	1-1/2"	1-1/2"	4"	1/8"	1/4" FH	.57	2 ea
205244	n/a	4"	2"	2"	4"	1/8"	1/4" FH	.72	2 ea
205246	n/a	5"	2-1/2"	2-1/2"	5"	1/8"	1/4" FH	1.07	2 ea

Designed for applications where extra strength and corrosion resistance are required. Features silent movement and no rattle due to integral nylon bearings. Commercial door screw hole pattern.

LED LIGHT ACTIVATED CABINET LIGHT

Injection Molded Nylon



Bulk	Display	A	B	C	LED Color	Fastener	Wt.(lb.)	Std. Pack
227154	227154-1	6-7/8"	1-5/16"	3/4"	White	#10 FH	.16	5 ea

The light/motion activated cabinet light has 4 super bright LEDs and can be mounted in any enclosed area using the provided strip of two-sided tape. The light is battery powered and uses 3 AAA batteries (included), so no wiring is necessary. The two center bulbs have a 60° beam angle for directed lighting while the two outside bulbs have a 120° beam angle for wide angle lighting.

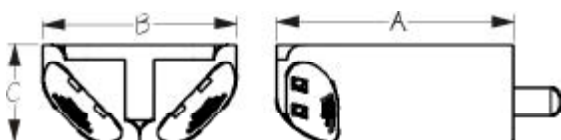

LED SWITCH ACTIVATED CABINET LIGHT

Injection Molded Nylon



Bulk	Display	A	B	C	LED Color	Fastener	Wt.(lb.)	Std. Pack
227162	227162-1	2"	1-5/8"	13/16"	White	#10 FH	.17	5 ea

Cabinet light has 4 super bright LEDs and its small size allows it to be mounted (stainless steel mounting screws included) in any cabinet, locker, or other places where short access lighting is needed. The double switches allow the light to be activated on one side at a time, or both sides at once. The light is battery powered and uses 6 LR44 batteries (included), so no wiring is necessary.

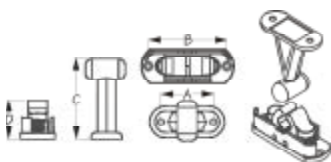

SPRING LOADED HORIZONTAL MOUNT DOOR CATCH

Injection Molded Nylon



Bulk	Display	A	B	C	D	Fastener	Wt.(lb.)	Std. Pack
227181	227181-1	1-9/16"	2-3/8"	2-38"	1-5/16"	#8 RH	.07	10 ea

Heavy-duty stainless steel springs provide an extremely strong catch mechanism to securely hold doors and hatches. Stainless steel mounting screws included.

SPRING LOADED VERTICAL MOUNT DOOR CATCH

Injection Molded Nylon

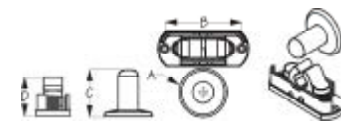

Bulk	Display	A	B	C	D	Fastener	Wt.(lb.)	Std. Pack
227186	227186-1	1-7/16"	2-3/8"	1-7/16"	1-5/16"	#8 RH	.06	10 ea

Heavy-duty stainless steel springs provide an extremely strong catch mechanism to securely hold doors and hatches. Stainless steel mounting screws included.

LED STUD MOUNT HAND RAIL

Formed 304 Stainless

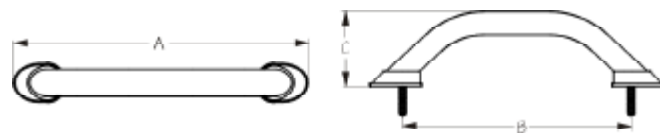

Bulk	Display	A	B	C	LED Color	Finish	Tube O.D.	Fastener	Wt.(lb.)	Std. Pack
254509	254509-1	9"	7-7/8"	2-1/2"	Blue	Stainless	15/16"	5/16"-18 Nut	.40	5 ea
254512	254512-1	12"	10-7/8"	2-1/2"	Blue	Stainless	15/16"	5/16"-18 Nut	.51	5 ea
254518	254518-1	18"	16-7/8"	2-1/2"	Blue	Stainless	15/16"	5/16"-18 Nut	.69	5 ea

LED Stud Mount Hand Rails have one blue LED in each mounting base piece and are shipped as three pieces – one handrail and two bases. 12 volt DC.

CANVAS SNAP WITH D-RING - STUD

304 Stainless

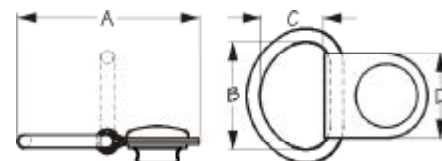

Bulk	Display	A	B	C	D	Wt.(lb.)	Std. Pack
n/a	299257-1	1-3/4"	1"	5/8"	3/4"	.04	5 pr
n/a	299257-2	1-3/4"	1"	5/8"	3/4"	1.00	5 Bags

Works with all Sea-Dog Adhesive Snap sockets and all standard stainless steel marine sockets.

Display pack (-1) contains 2 pieces

Display pack (-2) contains 10 pieces

DOCK LINE

Twisted Nylon

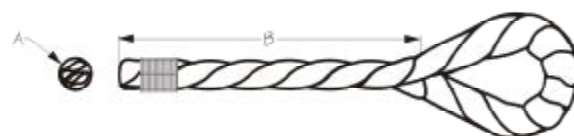

Bulk	Display	A (Dia.)	B (Length)	Color	WLL-kgs/lbs	B.S.-kgs/lbs	Wt.(lb.)	Std. Pack
n/a	301112010BK-1	1/2"	10'	Black	415/915	2080/4200	.37	12 ea
n/a	301112010BL-1	1/2"	10'	Blue	415/915	2080/4200	.37	12 ea
n/a	301112010WH-1	1/2"	10'	White	415/915	2080/4200	.37	12 ea
n/a	301112015BL-1	1/2"	15'	Blue	415/915	2080/4200	.40	12 ea
n/a	301112020BL-1	1/2"	20'	Blue	415/915	2080/4200	.45	12 ea
n/a	301112025BL-1	1/2"	25'	Blue	415/915	2080/4200	.50	12 ea
n/a	301116015BK-1	5/8"	15'	Black	900/1980	4500/9100	.47	6 ea
n/a	301116015WH-1	5/8"	15'	White	900/1980	4500/9100	.47	6 ea

Twisted Nylon Dock Lines

- 100% premium twisted three-strand nylon
- High strength and superior stretch for the shock loads of boat wakes and harbor surges
- Superior abrasion resistance to counteract chafe
- Professionally hand-spliced with five tucks
- Yacht whipped at the bitter end and splice point
- All lines are medium lay
- 3/8" and 1/2" diameter lines have a 12" eye length
- 5/8" lines have a 15" eye length
- 3/4" lines have an 18" eye length
- Comes in an attractive plastic reclosable clamshell package





DOCK LINE

Double Braided Nylon



Bulk	Display	A (Dia.)	B (Length)	Color	WLL-kgs/lbs	B.S.-kgs/lbs	Wt.(lb.)	Std. Pack
n/a	302110010NV-1	3/8"	10'	Navy	376/825	1880/3800	.35	12 ea
n/a	302110050G/W-1	3/8"	50'	Gold/White	376/825	1880/3800	.65	4 ea
n/a	302112030NV-1	1/2"	30'	Navy	438/960	2190/440	.65	12 ea
n/a	302112050G/W-1	1/2"	50'	Gold/White	438/960	2190/4400	.75	4 ea
n/a	302116015BK-1	5/8"	15'	Black	927/2045	4650/9400	.60	6 ea
n/a	302116015G/W-1	5/8"	15'	Gold/White	927/2045	4650/9400	.60	6 ea
n/a	302116015NV-1	5/8"	15'	Navy	927/2045	4650/9400	.60	6 ea
n/a	302116015WH-1	5/8"	15'	White	927/2045	4650/9400	.60	6 ea
n/a	302116020NV-1	5/8"	20'	Navy	927/2045	4650/9400	.60	6 ea
n/a	302116030NV-1	5/8"	30'	Navy	927/2045	4650/9400	.70	6 ea

Double Braided Nylon Dock Lines

- 100% premium double braided nylon
- Professionally spliced soft eye at one end
- Yacht whipped at the bitter end and splice point
- 3/8" and 1/2" diameter lines have a 12" eye length
- 5/8" lines have a 15" eye length
- 3/4" lines have an 18" eye length
- Comes in an attractive plastic reclosable clamshell package
- Comes in a wide range of colors and sizes



UTILITY CORDAGE

Solid Braided Polyester Cord



Bulk	Display	Description	A (Dia.)	B (Length)	Color	WLL-kgs/lbs	B.S.-kgs/lbs	Wt.(lb.)	Std. Pack
n/a	303304100-1	Hank	5/32"	100'	White	132/290	660/1330	1.50	12 ea
n/a	303305100-1	Hank	3/16"	100'	White	50/110	252/510	1.20	12 ea

Utility Cordage

- Solid braid polyester cord
- Excellent for many quick ties and flag halyard uses

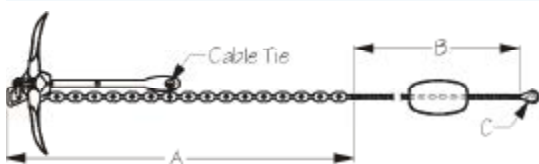

FOLDING ANTI-SNAG ANCHOR KIT

Hot Dipped Galvanized Iron/Forged Flukes



Bulk	Display	A	B	C	Anchor Chain Length	Line/Length	Boat Length	Wt.(lb.)	Std. Pack
318003KP	n/a	3'	30'	1"	3'	1/4"/25'	5' - 12'	5*	1 ea

The Sea-Dog Folding Anti-Slag Anchor Kit makes an ideal primary anchor on smaller boats, sailboats and inflatable boats. Cable tie break away from anchor chain for easy retrieval. Includes 3 lb. folding anchor with 3' vinyl coated anchor chain and 30' of 1/4" line, adjustable float and stainless fast eye boat snap (146123). *Weights vary due to metal and coating content. Listed weights are approximate.



FILLET & PREP TABLE - SQUARE RAIL MOUNT (MEDIUM)

Injection Molded Polypropylene



Bulk	Display	A	B	C	D	Fits Tubing	Wt.(lb.)	Std. Pack
n/a	326530-3	20"	12-5/8"	13-1/2"	2"	1" - 1-1/4"	3.50	1 ea

- Includes the 326599-1 Rail Mount Adapter, the 327197-1 Removable Square Rail Mount Clamps (pair), and all necessary hardware.
- Solid one-piece construction provides a strong long-lasting part that is easy to clean and maintain.
- UV stabilized high-density polyethylene.
- Measures 20" wide by 12-5/8" deep.
- Rail mounting system.
- Assembles in minutes, with all assembly hardware included.
- No drilling required.
- Easily accessible knife and pliers holder.
- Knife and pliers not included.



FILLET & PREP TABLE - SQUARE RAIL MOUNT (LARGE)

Injection Molded Polypropylene



Bulk	Display	A	B	C	D	Fits Tubing	Wt.(lb.)	Std. Pack
n/a	326535-3	30"	12-5/8"	13-1/2"	2-3/8"	1"-1-1/4"	5.50	1 ea

- Includes the 326599-1 Rail Mount Adapter, the 327197-1 Removable Square Rail Mount Clamps (pair), and all necessary hardware.
- Solid one-piece construction provides a strong long-lasting part that is easy to clean and maintain.
- UV stabilized high-density polyethylene.
- Measures 30" wide by 12-5/8" deep.
- Rail mounting system.
- Assembles in minutes, with all assembly hardware included.
- No drilling required.
- Easily accessible knife(6), pliers holder(2) and hose holder(2).



REMOVABLE SQUARE RAIL MOUNT CLAMPS

Injection Molded Nylon/Stainless

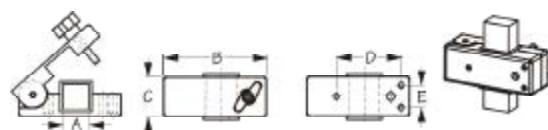

Bulk	Display	A	B	C	D	E	Wt.(lb.)	Std. Pack
n/a	327197-1	1" - 1-1/4"	3-7/8"	1-7/16"	2-1/2"	7/8"	.32	6 pr

Removable Square Rail Mount Clamps fit 1" to 1-1/4" square tubing. Includes shims, thumb screws and all mounting hardware. Great for mounting a wide variety of items including cup holders, GPS, cell phone holder, etc. to your existing square rails. No drilling required.



DECK PLATE BAG

Nylon/Stainless Steel Ring

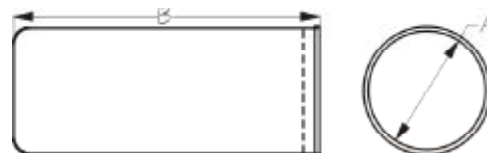

Bulk	Display	A	B	Wt.(lb.)	Std. Pack
337189R	n/a	8"	10"	.20	10 ea

Fits all Sea-Dog Line deck plates with an internal collar.

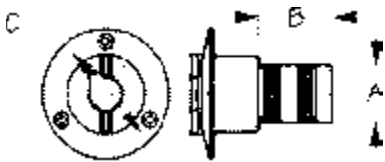

LOCKING HOSE DECK FILL

Investment Cast 316 Stainless



Bulk	Display	Body Marking	A	B	C	Fastener	Wt.(lb.)	Std. Pack
351322L	n/a	Water	1-1/2" Hose	3-1/4"	3-7/16"	#10 FH	1.25	1 ea

Locking Hose Deck Fill prevents theft and includes two keys. The cap threads are 1-1/2"-11-1/2 NPSM-Straight and fits all of our 2" stainless steel deck fills. 351330L & 351331L use body part number 351400.

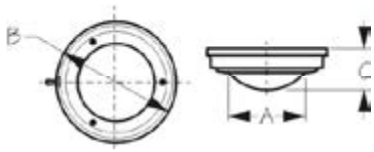

LED DOME LIGHT

Teak/Stamped Polished Brass



Bulk	Display	A	B	C	Fastener	Wt.(lb.)	Std. Pack
400199	400199-1	4"	5-3/4"	2"	#8 FH	.80	1 ea / 5 ea
400209	400209-1	5"	6-1/8"	2-1/16"	#8 FH	.95	1ea / 5 ea

Each Teak Dome Light has a solid teak base with a lacquer coated brass trim ring. LED Dome Lights have very low current consumption at .068 amps at 12 volts and have extreme long life. LED Dome Lights give off very low heat and are resistant to vibration. LED Dome Lights have 18 white LEDs per light.

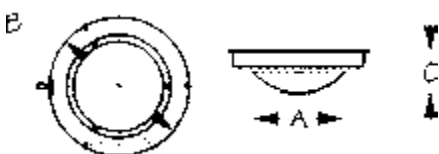

LED DAY/NIGHT DOME LIGHT

Stamped Polished Brass



Bulk	Display	A	B	C	Fastener	Wt.(lb.)	Std. Pack
400358	400358-1	5"	6-3/4"	2-1/8"	#6 RH	.87	1 ea / 5 ea

LED Dome Lights have very low current consumption at .068 amps at 12 volts and have extreme long life. LED Day/Night Dome Lights give off very low heat and are resistant to vibration. LED Dome Lights have 15 white LEDs per light and 5 red LEDs.

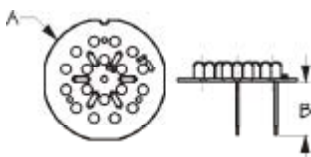

LED DOME LIGHT PCB REPLACEMENT BOARD

Plastic



Bulk	Display	A	B	No. of LEDs	PCB Board Type	Fastener	Wt.(lb.)	Std. Pack
401729	n/a	2-5/16"	5"	18	Day	#6 RH	.02	1 ea
401759	n/a	2-5/16"	5"	15/5	Day/Night	#6 RH	.02	1 ea

LED Dome Light PCB Boards have very low current consumption at .068 amps at 12 volts and have extreme long life. LED Dome Lights give off very low heat and are resistant to vibration. Direct replacement for 401725, 401727, 401755 and 401757. Can also be used in most dome lights to update to LED.

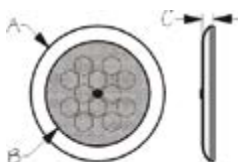

LED LOW PROFILE TASK LIGHT (SMALL)

Stainless



Bulk	Display	A	B	C	Ring Finish	LED Color	Fastener	Wt.(lb.)	Std. Pack
401666	401666-1	2-9/16"	1-3/8"	9/32"	Satin	White	#6 FH	.09	10 ea / 5 ea

100 Lumens - Less than 0.2 amps - Low Profile Task Lights have 6 LEDs in each light and are rated at 12 VDC. Built-in on/off switch, just press on center of lens.



LED SQUARE FLOOD LIGHT

Powder Coated Aluminum/Stamped 304 Stainless Bracket

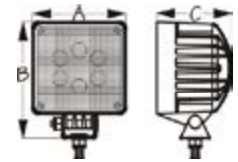

Bulk	Display	A	B	C	No. of LEDs	Amps	Volts	Lumens	Wt.(lb.)	Std. Pack
n/a	405330-3	4"	5"	3-1/2"	6	2 A	12/24 V	1000	1.60	1 ea

This marine grade LED flood light has 6 super bright LEDs and a stainless steel mounting bracket. Waterproof IP 68 rating.



STAINLESS STEEL SPOT/FLOOD LIGHT

304 Stainless Steel

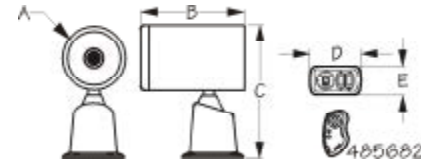

Bulk	Display	A	B	C	D	E	Spot Watts	Flood Watts	Wt.(lb.)	Std. Pack	
n/a	405720-3	4-1/2"	8-1/4"	9-7/8"	5-1/4"	2-15/16"	100 W	90 W	4.00	1 ea	
n/a	405682-1	Wireless Remote Control for 405720-3								.35	1 ea
n/a	405692-1	Wireless 12 Volt Second Station for 405720-3								.22	1 ea

Cast 316 stainless steel base and stamped 304 stainless steel body and reflector with a classic and traditional look with a contemporary flair. Five year warranty. Combination 100W spot/90 watt flood halogen bulb produces 165,000 candlepower, 2500 lumens. Waterproof, with an IP rating of 67. Two speed motor. Digital phone cable connection, 15' cable included. Joystick control panel included. Spotlight draws 8.3 amps @ 12 volts. Floodlight draws 7.5 amps @ 12 volts. The motor by itself draws .5 amps at 12 volts. Wireless remote and 12 volt second station sold separately.



LED (CREE) DOCKING LIGHTS

Stamped 304 Stainless

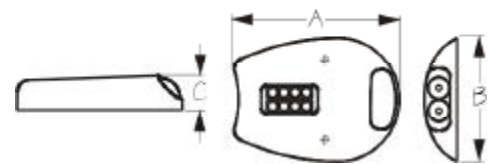

Bulk	Display	A	B	C	LEDs	Lumens	Amp Draw	Fastener	Wt.(lb.)	Std. Pack
405951	405951-1	3-9/16"	2-5/8"	3/4"	10	300	.28@12V	#8 RH	.19	1 pr

Two high power Cree LED bulbs provide 1000 Lumens light output from the front array, with a focused beam angle of 10° for a concentrated light beam. Six regular LED bulbs on the top array have a wide angle beam of 90° to illuminate a large portion of the dock area. Surface mount with a small footprint makes for easy installation, and these lights are waterproof with an IP rating of 68. Front lights and top lights can be controlled separately.

KILL SWITCH 10 KEY UNIVERSAL LANYARD

Injection Molded Nylon & Delrin



Bulk	Display	Length	Wt.(lb.)	Std. Pack
n/a	420496-1	50"	.10	10 ea

10 Key Lanyard fits Johnson, Evinrude, Mercury, Yamaha, Honda, Tohatsu, Suzuki, Kawasaki, OMC and Nissan kill switches.

REPLACEMENT RED INSERT FOR FUSE HOLDER

Stamped Brass/Molded Bakelite

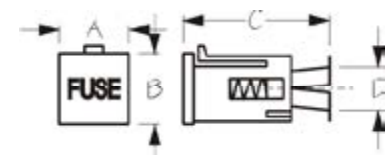

Bulk	Display	A	B	C	D	Release Location	Wt.(lb.)	Std. Pack
n/a	422199-1	7/16"	7/16"	1"	1/4"	Side	.01	10 pr

Replacement Red Insert is used on fuse holder, 420501 and panels, 422010, 422110, 422310 and 422510.

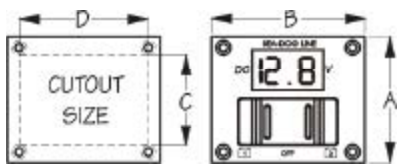

WAVE LED BATTERY TEST ROCKER SWITCH PANEL

Injection Molded Nylon



Bulk	Display	A	B	C	D	Voltage	Wt.(lb.)	Std. Pack
n/a	425020-1	2-7/16"	2-15/16"	2"	2-1/2"	12 DC	.20	1 ea

The Wave LED Battery Test Rocker Switch Panel includes an illuminating rocker SPDT switch and bright LED display to monitor voltage of two batteries.

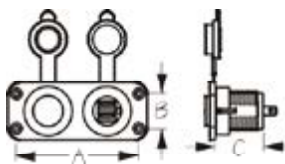

DOUBLE USB & POWER SOCKET PANEL

Injection Molded Nylon



Bulk	Display	A	B	C	Wt.(lb.)	Std. Pack
426505	426505-1	3-1/2"	1"	1-5/8"	.16	10 ea

Double USB Input 12V-24V, Output DC 5V/2.1A. Output for each USB outlet is 2.1 Amps – enough to charge iPhones, iPads and almost all other devices. Power Socket rated at 12 volts, 16 amps. Includes screws and connectors.

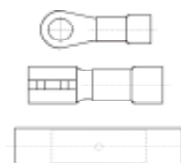

ELECTRICAL CONNECTOR MIXED KIT

Tin Plated Copper/Injection Molded Nylon



Bulk	Display	Type	Wt.(lb.)	Std. Pack
n/a	429500-1	Butt, Push-On & Ring Terminals	.35	10 ea

Electrical Connector Mixed Kit contains:

Butt Connectors: 22-18 ga. (5), 14-16 ga. (5), 12-10 ga. (5)

Push-On Terminals: 22-18 ga. (2), 14-16 ga. (2), 12-10 ga. (2)

Ring Terminals: 22-18ga. (2), #8 & #10 Rings, 14-16ga. (2), #8 & #10 Rings, 12-10ga. (2), #8 & #10 Rings and 12-10ga. 3/8" (2)



MAX BLAST SINGLE MINI COMPACT HORN

Stamped 304 Stainless Cover



Bulk	Display	Amps	db	Finish	A	B	C	Wt.(lb.)	Std. Pack
431115	431115-1	4 A	106	Stainless	3-5/16"	3-5/8"	1-9/16"	.75	12 ea / 6 ea

An injection-molded housing under the stainless steel cover protects the steel cover from rusting, leaving it completely rust-free after a 600 hour salt spray test.

This horn comes with a FIVE YEAR rust-free warranty. Meets ABYC standard A-23, NMMA type accepted #748120 for use on vessels under 39'. 12 volt DC.

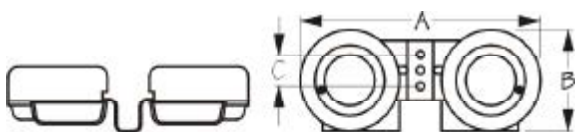

MAX BLAST TWIN MINI COMPACT HORN

Stamped 304 Stainless Cover



Bulk	Display	Amps	db	Finish	A	B	C	Wt.(lb.)	Std. Pack
431125	431125-1	8 A	109	Stainless	8"	3-5/16"	1"	1.58	6 ea

An injection-molded housing under the stainless steel covers protects the steel covers from rusting, leaving it completely rust-free after a 600 hour salt spray test.

This horn comes with a FIVE YEAR rust-free warranty. Meets ABYC standard A-23, NMMA type accepted #748120 for use on vessels under 39'. 12 volt DC.





BILLET SCREW-IN GRILL COVER FOR 431255 HORN*

304 Stainless

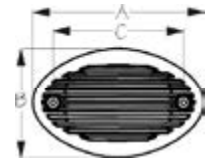

Bulk	Display	Grill Finish	A	B	C	Wt.(lb.)	Std. Pack
431354	n/a	Stainless	5-1/4"	3-3/8"	4"	.09	10 ea

*Must be used along with a 431351, 431352, or 431353 grill on a 431255 horn.



TRUMPET HORN TUBE COVER

304 Stainless

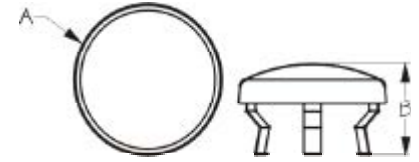

Bulk	Display	A	B	Wt.(lb.)	Std. Pack
n/a	432590-1	3-15/16"	2-3/16"	.40	1 ea

Stainless steel trumpet tube cover fits all Sea-Dog air horns and the Max Blast electric trumpet horns. Keeps green water and bugs from getting into the trumpet tube, and snaps over the end of the tube – no installation necessary.



SEA-DOG LINE BOAT HOOK

Injected Molded Nylon/Aluminum



NEW

Bulk	Display	A	B	Style	Wt.(lb.)	Std. Pack
n/a	491012-1	48"	n/a	1 Piece	.50	10 ea
n/a	491013-1	72"	n/a	1 Piece	.70	10 ea
n/a	491021-1	24"	36"	2 Piece	.40	10 ea
n/a	491024-1	48"	96"	2 Piece	1.00	10 ea
n/a	491034-1	36"	96"	3 Piece	1.00	10 ea
n/a	491036-1	56"	144"	3 Piece	1.20	10 ea
n/a	491050-1	Cap Only			.01	1 ea
n/a	491051-1	Hook Only (Small) 1" O.D.			.04	1 ea
n/a	491052-1	Hook Only (Large) 1-1/8" O.D.			.06	1 ea

Sea-Dog boat hooks feature an over-molded soft rubber coated hook to protect your boat from scuffs and scratches. The bright orange rubber tip cover is readily visible and removes for accessory attachment. The four-point hook attachment, comfort grip handle, and marine grade aluminum tubing make for a high quality and durable accessory. Its buoyant design keeps the boat hook afloat for more than six minutes.

Replacement Hooks

491051-1 (small hook): used on models 491021-1, 491024-1, 491034-1, and 491036-1.

491052-1 (large hook): used on models 491012-1 and 491013-1.



BOAT HOOK SQUEEGEE BRUSH

Injected Molded Nylon/Rubber

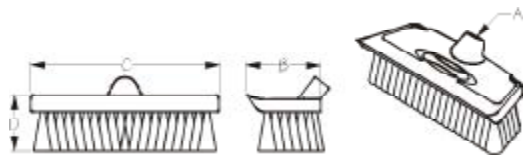

Bulk	Display	A	B	C	D	Wt.(lb)	Std. Pack
n/a	491075-1	Universal	3-1/4"	10-3/8"	2-3/4"	.80	8 ea

Soft brush with squeegee, fits all Sea-Dog Boat Hooks.

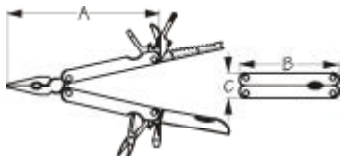

MULTI-TOOL

304 Stainless



Bulk	Display	A	B	C	Wt.(lb.)	Std. Pack
n/a	563151-1	6"	3-15/16"	1"	.31	1 ea

This handy Multi-Tool is made from 304 stainless steel. It includes a knife, needle nose pliers, cutters, scissors, various screw drivers, bottle opener, file and a saw. Canvas carrying case included.

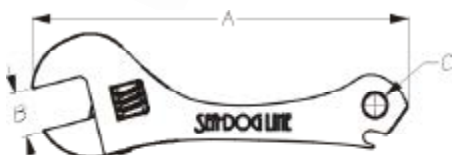

ADJUSTABLE WRENCH

Cast 17-10 Stainless



Bulk	Display	A	B	C	Wt.(lb.)	Std. Pack
563255	563255-1	5-1/2"	3/4"	1/4" Hex Head	.34	1 ea

Cast 17-10 grade stainless steel adjustable wrench is made to last a lifetime under any conditions. It includes a 1/4" hex head and bottle opener.



LED WATERPROOF FLASH LIGHT

Aluminum



Bulk	Display	A	B	Wt.(lb.)	Std. Pack
570105	570105-1	4-7/16"	1"	.22	1 ea / .1 ea

The LED Waterproof Flash Light has an IP Rating of 67. Requires 3 AA batteries, not included.

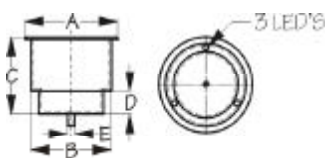

LED FLUSH MOUNT COMBO DRINK HOLDER W/ DRAIN FITTING

Stamped 304 Stainless



Bulk	Display	Hole Required	A	B	C	D	E	LED Color	Wt.(lb.)	Std. Pack
588071	588071-1	3-3/4"	4-3/8"	3-11/16"	3-3/16"	15/16"	5/16"	3 Red	.27	5 ea
588074	588074-1	3-3/4"	4-3/8"	3-11/16"	3-3/16"	15/16"	5/16"	3 Blue	.27	5 ea

LED Drink Holder has three LEDs and is available with red or blue lights. Dual purpose design allows the use of beverage cans with or without insulated can wraps, as well as most sizes of bottles. The bottom is padded with a rubber insert to prevent rattling, and the drain fitting allows water to be drained into the bilge – use 1/4" tubing secured with a tie-wrap. 12 volt DC.

BOAT HOOKS

Sea-Dog Boat Hooks come in a wide range of sizes, some fixed in length (1 piece) and some with variable lengths (2 and 3 piece).

Twist at the knurled grip to operate the hook's telescopic feature.

See p. 8 for sizes and dimensions

1 | Rubber Tip Cover

A screw-on soft rubber tip prevents scuffing and is removable for accessory attachment. Bright orange color provides easy in-the-water visibility.

2 | Over-Molded Rubber Hook

Our boat hook features an over-molded soft rubber coating to protect your boat from scuffs and scratches.

3 | 4-Point Hook Attachment

The hook is attached at four points on the aluminum pole instead of the usual two on most competitive models for greater strength and durability.

4 | Marine Grade Aluminum Tubing

Every Sea-Dog boat hook is made from marine grade aluminum tubing, allowing for smooth and reliable operation over the life of the product.

5 | Comfort Grip Handle

The UV protected rubber handle provides a cushioned grip and comes with pliable hanging loop.

6 | Mooring Hook Attachment Platform

The boat hook features a pre-drilled platform area to install a mooring hook.

7 | Knurled Telescopic Grip

Each telescopic boat hook model features a knurled grip to allow for easier gripping and operation.

8 | Buoyant Design

Sea-Dog boat hooks have been tested for buoyancy in both fresh water and salt water, and remain buoyant for over 5 minutes.



8



5



TWIST

7

BUILDING A BETTER --- BOAT HOOK

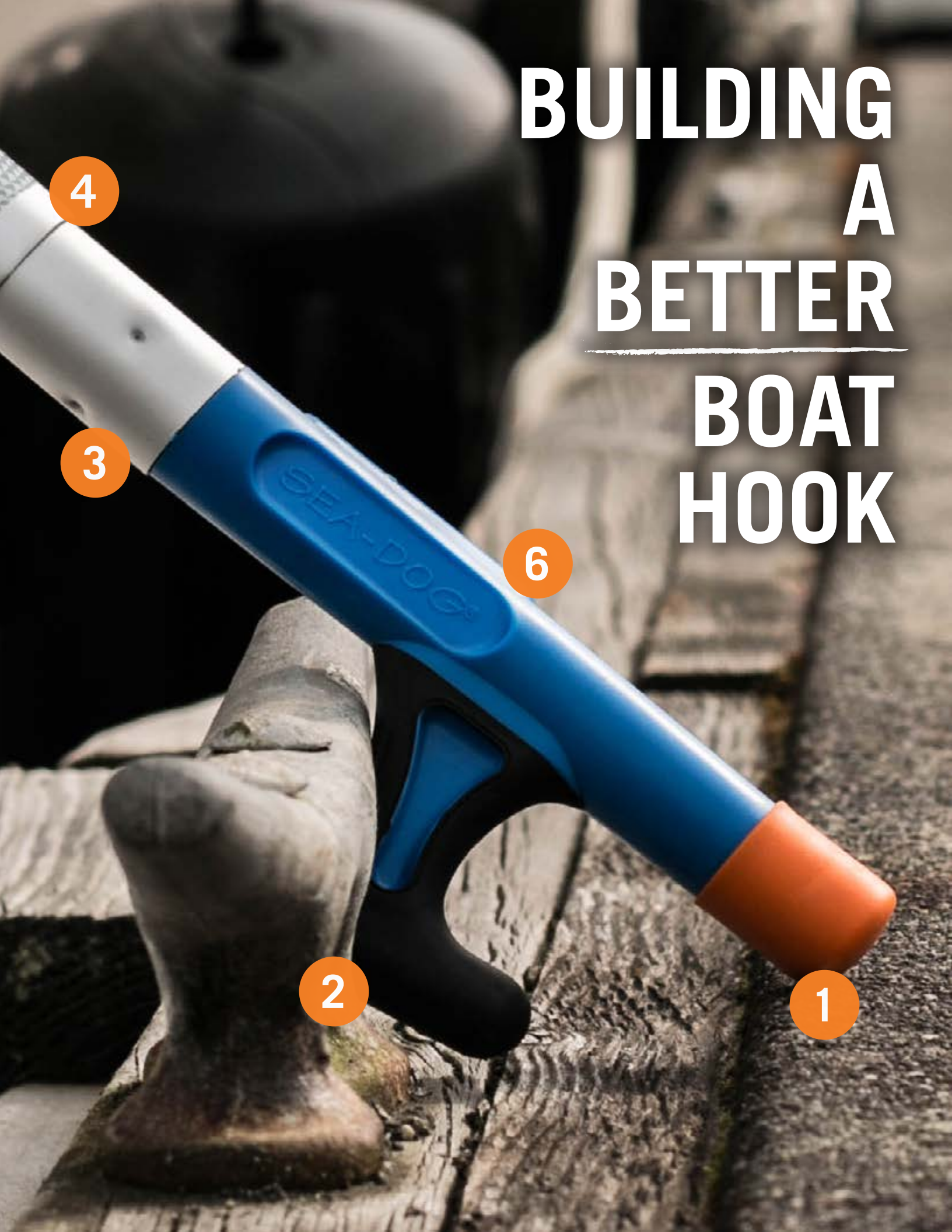

4

3

6

2

1

PLANOGRAM & POP DISPLAYS

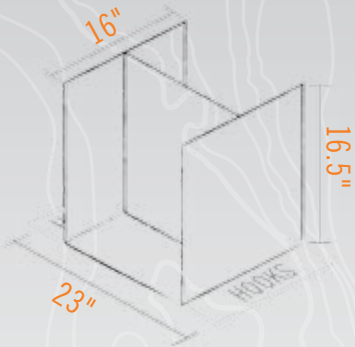

COUNTER TOP SPINNER

POP



916001-H

The new counter top H-style spinner puts some of our top-selling POP's and general merchandise products into a compact and attractive spinning display.

See p. 14 for spinner contents

HORN PLANOGRAM

916156P



Put a full selection of the top selling electric horns—plus the new over-molded compacts—in one complete planogram display. Display includes horns, sign, hooks, and back tags.

See p. 14 for included horn products



Panel includes new over-molded Max Blast Compact Horns (single & double).

BOAT HOOK SPINNERS

The new Sea-Dog three-sided and four-sided boat hook spinner displays put a supply of our complete boat hook product line in a compact, easy to service space on the showroom floor.

3-SIDED DISPLAY

916001-BH3

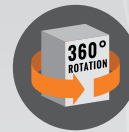

4-SIDED DISPLAY

916001-BH4



Like the other Sea-Dog merchandisers, these displays make our "Build A Better Boat Hook" line of products easy to buy and easy to sell, and the upright spinning display makes it easy for your customers to see all of the features and benefits of this new line of products. Just buy the mixed pack of boat hooks and receive the spinner and signage for free. After a quick and easy assembly process, you're ready to start selling the full line of Sea-Dog boat hooks.

See p. 14 for spinner contents



Each spinner comes with a boat hook feature poster and a laminated hanging card with complete product details.

Counter Top Spinner

The new counter top H-style spinner puts some of our top-selling POP's and general merchandise products into a compact and attractive spinning display.



Counter Top Spinner (916001-H)		
Part #	Description	Quantity
Side Panel 1		
357015-1	CAP FOR 357010-GAS(RED)	2
357399-1	NYLON DECK PLATE KEY	2
588450-1	STAINLESS BOTTLE OPENER	2
299114-1	CANVAS SNAP STUD(#8 SHEET META L SCREW - SELF TAP) 1/2" 6 PER	2
299260-1	CANVAS SNAP WITH TIE WRAP LOOP (SET OF 6)	2
299255-1	CANVAS SNAP SOCKET W/D-RING	2
357094-1	REPLACEMENT FLIP CAP - WASTE(BLACK)	2
568010-1	CORK KEY FLOAT	2
335690-1	STAINLESS UNIVERSAL DECK PLATE KEY	2
299190-1	CANVAS SNAP TOOL	2
351390-1	REPLACEMENT CAP / CHAIN FOR 351320-351323	2
Inside Panel 1		
429900-1	POWDER COATED STEEL WIRE STRIP PER/CRIMPER - ECONOMY	2
429920-1	POWDER COATED STEEL CRIMPER - HEAT SHRINK ONLY	2
429930-1	WIRE STRIPPER AND CUTTER	2
POP's 1		
147810-5	GALVANIZED ANCHOR SHACKLE-3/8" NON RATED POP DISPLAY - 30 PC	1
520070-5	BRASS SNAP HANDLE DRAIN PLUG 1" & POP DISPLAY - 25 PIECES	1
571252-5	POLICE WHISTLE POP DISPLAY- 35 PIECES	1

Part #	Description	Quantity
Side Panel 2		
422199-1	RED INSERT FOR 422010,422110,	2
444190-1	AGC FUSE - MIXED KIT	2
441090-1	LIGHT BULB #90, DOUBLE BAYONET 13V-.58A	2
441094-1	LIGHT BULB #94, DOUBLE BAYONET 12.8V-1.04A	2
429500-1	NYLON ELECTRICAL CONNECTORS - MIXED KIT	2
445090-1	MINI BLADE FUSE - MIXED KIT	2
445190-1	ATO/ATC FUSE - MIXED KIT	2
426512-1	USB POWER PLUG - DOUBLE	2
426115-1	DELUXE POWER SOCKET - 12 VOLT (SOCKET & CAP)	2
420465-1	BRASS TOGGLE SWITCH - ON/OFF	2
193420-1	STAINLESS RELEASE PIN-1/4 X 2 INCH	2
331360-1	STAINLESS MIDGET VENT(SMALL)	2
420500-1	IN-LINE FUSE WITH 20 AMP FUSE	2
Inner Panel 2		
420495-1	7 KEY LANYARD ONLY	2
429590-1	HEAT SHRINK FLAME TORCH	2
751011-1	GALVANIZED COUPLER LOCKING PIN - 5/16"	2
563150-1	STAINLESS STEEL MULTI TOOL	2
POP's 1		
151580-5	STAINLESS SNAP HOOK-3 1/4 INCH (T) POP DISPLAY - 25 PIECES	1
520041-5	REPLACEMENT PLUG FOR 520040 POP DISPLAY - 30 PIECES	1
520080-5	BRASS TEE HANDLE DRAIN PLUGS 1" & POP DISPLAY - 30 PCS	1

Horn Planogram

Put a full selection of the top selling electric horns plus the new over-molded compacts in one complete planogram display. Display includes horns, sign, hooks, and back tags.

Horn Planogram (916156P)		
Part #	Description	Quantity
431115-1	MAX BLAST SINGLE MINI COMPACT HORN	2
431125-1	MAX BLAST TWIN MINI COMPACT HORN	2
431110-1	SINGLE MINI COMPACT HORN	2
431120-1	TWIN MINI COMPACT HORN	2
431151-1	SONIC MINI COMPACT HORN	2
431152-1	SONIC MINI COMPACT HORN	2
431153-1	SONIC MINI COMPACT HORN	2
431230-1	DROP-IN HIDDEN HORN V.2 WITH GRILLS	2
431250-1	DROP-IN HIDDEN HORN V.3 WITH GRILLS	2
431510-1	MAX BLAST SINGLE TRUMPET HORN	1
431520-1	MAX BLAST DUAL TRUMPET HORN	1

Boat Hook Spinners

The new Sea-Dog three-sided and four-sided boat hook spinner displays put a supply of our complete boat hook product line in a compact, easy to service space on the showroom floor.

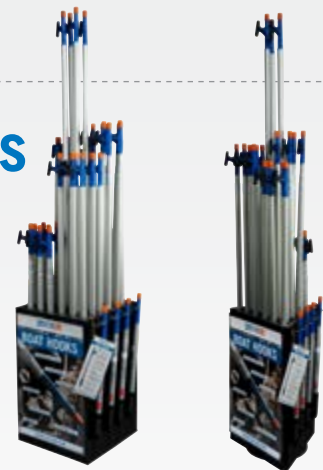

4-Sided Spinner (916001-BH4)		
Part #	Size (in)	Quantity
491012-1	48"	8
491013-1	72"	4
491021-1	24"-36"	4
491024-1	48"-96"	8
491034-1	36"-96"	8
491036-1	56"-144"	8
Total		40

3-Sided Spinner (916001-BH3)		
Part #	Size (in)	Quantity
491012-1	48"	4
491013-1	72"	3
491021-1	24"-36"	4
491024-1	48"-96"	6
491034-1	36"-96"	4
491036-1	56"-144"	4
Total		25

NEW FROM

SEADOG[®]LINE
QUALITY MARINE GEAR

MAX BLAST MINI COMPACT SINGLE AND DUAL HORNS
5 year rust-free warranty

NEW OUT OF THE BOX



AFTER 600 HR SALT SPRAY TEST



NO RUST OR CORROSION AFTER 600 HOURS!

An injection-molded housing under the stainless steel cover protects the steel cover from rusting, leaving it completely rust-free after a 600 hour salt spray test.

These horns come with a FIVE YEAR rust-free warranty and meet ABYC standard A-23, NMMA type accepted #748120 for use on vessels under 39'. 12 volt DC.



WWW.SEA-DOG.COM



EXPERIENCE THE SEA-DOG DIFFERENCE

SEADOG[®]LINE
QUALITY MARINE GEAR

- A.** P.O. Box 479
Everett, WA 98206
- P.** 1-866-732-3641
- F.** 425-339-1345
- W.** www.sea-dog.com